

**ECOLEC Price List 2021**

Please telephone 01902 457575

Available  
from electric  
wholesalers and  
NICEIC engineers

Wireless Heating Systems

*All local space heaters manufactured for sale in the EU after 1st January 2018 which use electricity, gaseous or liquid fuels, must comply with a minimum efficiency standard. This includes electric radiators, electric underfloor heating and electric and gas fires.*

**PROUDLY MANUFACTURED IN THE UK**

SPACE SAVING VERTICAL & HORIZONTAL RADIANT PANEL WITHOUT VENTS (DEPTH 40mm)							EFS 1001
LINE REF	CODE	DIMENSIONS (H X W X D) MM	ELEMENT (WATTS)	OUTPUT (WATTS)	OUTPUT (BTU'S)	PRICE INC. VAT	PRICE EXC. VAT
<b>Powder Coated White RAL 9016</b>							
1.1	ECO 2000D/RP/PC/RX	2000 x 500 x 40	2000	1600	5459	489.00	407.50
1.2	ECO 1500D/RP/PC/RX	1500 x 500 x 40	1500	1200	4094	419.00	349.17
1.3	ECO 1000D/RP/PC/RX	1000 x 500 x 40	1000	800	2729	363.00	302.50
1.4	ECO 750D/RP/PC/RX	750 x 500 x 40	750	600	2047	285.00	237.50
1.5	ECO 500D/RP/PC/RX	500 x 500 x 40	500	400	1365	242.00	201.67
1.6	ECO 1000D/SB/RP/PC/RX	2000 x 250 x 40	1000	800	2729	387.00	322.50
1.7	ECO 750D/SB/RP/PC/RX	1500 x 250 x 40	750	600	2047	340.00	283.33
1.8	ECO 500D/SB/RP/PC/RX	1000 x 250 x 40	500	400	1365	290.00	241.67
3.9	<b>Selected Powder Coated RAL COLOURS available for additional charge to Line Ref. 1.1 to 1.8</b>					132.00	110.00

SPACE SAVING VERTICAL IP44 GLASS RADIATOR - Body & Glass in matching RAL Colours							EFS 1005
LINE REF	CODE	DIMENSIONS (H X W X D) MM	ELEMENT (WATTS)	OUTPUT (WATTS)	OUTPUT (BTU'S)	PRICE INC. VAT	PRICE EXC. VAT
4.3	ECO 1000D/IP44/GR/RX	1000 x 500 x 44	1000	600	2047	730.00	608.33
4.4	ECO 1500D/IP44/GR/RX	1500 x 500 x 44	1500	900	3070	820.00	683.33
4.5	ECO 2000D/IP44/GR/RX	2000 x 500 x 44	2000	1300	4435	990.00	825.00
4.6	ECO 500D/SB/IP44/GR/RX	1000 x 250 x 44	500	300	1023	680.00	566.67
4.7	ECO 750D/SB/IP44/GR/RX	1500 x 250 x 44	750	450	1535	750.00	625.00
4.8	ECO 1000D/SB/IP44/GR/RX	2000 x 250 x 44	1000	600	2047	820.00	683.33

















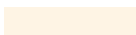

**SELECTED RAL COLOURS AVAILABLE - SEE CHART**

SPACE SAVING VERTICAL IP44 MIRROR RADIATOR - Available in White body only							EFS 1006
LINE REF	CODE	DIMENSIONS (H X W X D) MM	ELEMENT (WATTS)	OUTPUT (WATTS)	OUTPUT (BTU'S)	PRICE INC. VAT	PRICE EXC. VAT
5.3	ECO 1000D/IP44/MR/RX	1000 x 500 x 44	1000	600	2047	525.00	437.50
5.4	ECO 1500D/IP44/MR/RX	1500 x 500 x 44	1500	900	3070	605.00	504.17
5.5	ECO 2000D/IP44/MR/RX	2000 x 500 x 44	2000	1300	4435	700.00	583.33
5.7	ECO 750D/SB/IP44/MR/RX	1500 x 250 x 44	750	450	1535	475.00	395.83
5.8	ECO 1000D/SB/IP44/MR/RX	2000 x 250 x 44	1000	600	2047	600.00	500.00
5.9	ECO 500D/CIR/IP44/PC/RX	614 Diameter x 44	500	300	1023	540.00	450.00

SPACE SAVING VERTICAL IP44 BATHROOM PANEL (DEPTH 40mm)							EFS 1008
LINE REF	CODE	DIMENSIONS (H X W X D) MM	ELEMENT (WATTS)	OUTPUT (WATTS)	OUTPUT (BTU'S)	PRICE INC. VAT	PRICE EXC. VAT
<b>Powder Coated White RAL 9016</b>							
7.2	ECO 1500D/IP44/PC/RX	1500 x 500 x 40	1500	1200	4094	419.00	349.17
7.3	ECO 1000D/IP44/PC/RX	1000 x 500 x 40	1000	800	2729	363.00	302.50
7.4	ECO 500D/IP44/PC/RX	500 x 500 x 40	500	400	1365	242.00	201.67
7.6	ECO 546/IP44/PC/RX	600 x 400 x 40	500	400	1365	242.00	201.67
7.10	ECO 750D/IP44/PC/RX	750 x 500 x 40	750	600	2047	285.00	237.50
3.9	<b>Selected Powder Coated RAL COLOURS available for additional charge to Line Ref. 7.2 to 7.10</b>					132.00	110.00

Sharrocks Street, Wolverhampton WV1 3RP

Tel: 01902 457575 Fax: 01902 457797 Email: [sales@ecolec.co.uk](mailto:sales@ecolec.co.uk) Website: [www.ecolec.co.uk](http://www.ecolec.co.uk)

	RAL 1014 IVORY		RAL 6019 PASTEL GREEN		RAL 8004 COPPER BROWN
	RAL 1015 LIGHT IVORY		RAL 6034 PASTEL TURQUOISE		RAL 8017 CHOCOLATE BROWN
	RAL 5008 GREY BLUE		RAL 7016 ANTHRACITE GREY		RAL 9001 CREAM
	RAL 3003 RUBY RED		RAL 7024 GRAPHITE GREY		RAL 9010 PURE WHITE
	RAL 5002 ULTRAMARINE BLUE		RAL 7032 PEBBLE GREY		RAL 9006 SILVER GREY
	RAL 5015 SKY BLUE		RAL 7047 TELE GREY 4		RAL 9005 BLACK

Accessories				
8.2	Aluminium Towel Rail Powder-coated Silver 500mm factory fitted		40.00	33.33
	Aluminium Towel Rail Powder-coated Silver 500mm factory fitted x2		80.00	66.66



8.3	Adjustable Feet - Pair (8 pcs)		48.00	40.00
	only for use with max radiator height 500mm (must be mechanically fitted to floor by fitter on site)			



8.9	Adjustable Wall Mounted Brackets - Pair - factory fitted to the radiator		48.00	40.00
-----	--------------------------------------------------------------------------	--	-------	-------

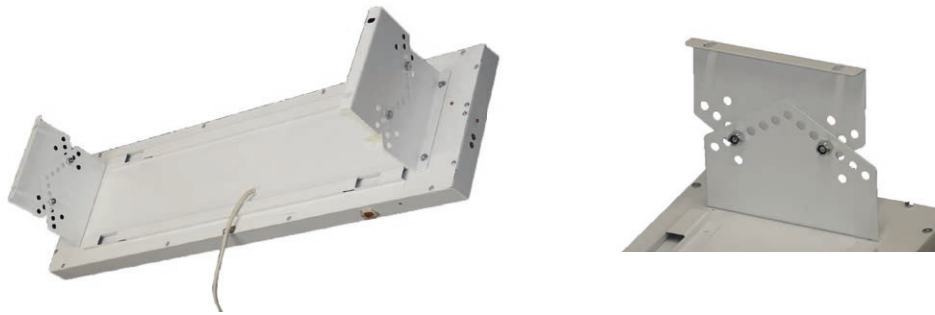

Room temperature sensor fitted inside



HEALTHCARE 43°C PANEL RADIATORS (DEPTH 40mm)							EFS 1054	
LINE REF	CODE	DIMENSIONS (H X W X D) MM	ELEMENT (WATTS)	OUTPUT (WATTS)	OUTPUT (BTU'S)	PRICE INC. VAT	PRICE EXC. VAT	
10.1	ECO 1000DLL/IP44/PC/RX/43	2000 x 500 x 40	1000	590	2013	489.00	407.50	
10.2	ECO 1000DL/IP44/PC/RX/43	1500 x 500 x 40	1000	443	1511	419.00	349.17	
10.3	ECO 500DLL/IP44/PC/RX/43	1000 x 500 x 40	500	295	1006	363.00	302.50	
10.4	ECO 500DL/IP44/PC/RX/43	750 x 500 x 40	500	222	757	285.00	237.50	
10.5	ECO 250DLL/IP44/PC/RX/43	500 x 500 x 40	250	148	505	242.00	201.67	
10.6	ECO 250DLL/SB/IP44/PC/RX/43	1000 x 250 x 40	250	148	505	290.00	241.67	
3.9	<b>Selected Powder Coated RAL COLOURS available for additional charge to Line Ref. 1.1 to 1.8</b>					132.00	110.00	

SPACE SAVING VERTICAL IP44 SAFE TO TOUCH 55°C RADIANT SCHOOL PANEL (DEPTH 40mm)							EFS 1013	
LINE REF	CODE	DIMENSIONS (H X W X D) MM	ELEMENT (WATTS)	OUTPUT (WATTS)	OUTPUT (BTU'S)	PRICE INC. VAT	PRICE EXC. VAT	
<b>Powder Coated White RAL 9016</b>								
12.1	ECO 1000DLL/IP44/PC/RX/55	2000 x 500 x 40	1000	860	2934	489.00	407.50	
12.2	ECO 1000DL/IP44/PC/RX/55	1500 x 500 x 40	1000	642	2190	419.00	349.17	
12.3	ECO 500DLL/IP44/PC/RX/55	1000 x 500 x 40	500	425	1450	363.00	302.50	
12.4	ECO 500DL/IP44/PC/RX/55	750 x 500 x 40	500	321	1095	285.00	237.50	
12.5	ECO 250DLL/IP44/PC/RX/55	500 x 500 x 40	250	214	730	242.00	201.67	
12.6	ECO 250DLL/SB/IP44/PC/RX/55	1000 x 250 x 40	250	214	730	290.00	241.67	
12.7	ECO 500DL/SB/IP44/PC/RX/55	1500 x 250 x 40	500	321	1095	340.00	283.33	
12.8	ECO 500DLL/SB/IP44/PC/RX/55	2000 x 250 x 40	500	425	1450	387.00	322.50	

**SELECTED RAL COLOURS AVAILABLE - SEE CHART**OTHER RAL COLOURS AVAILABLE, ASK FOR A QUOTE [SALES@ECOLEC.CO.UK](mailto:SALES@ECOLEC.CO.UK) OR PHONE 01902 457575

FAN HEATER (DEPTH 100mm) WORKS WITH WCT 100/TX CONTROLLER							EFS 1016	
LINE REF	CODE	DIMENSIONS (H X W X D) MM	ELEMENT (WATTS)	OUTPUT (WATTS)	OUTPUT (BTU'S)	PRICE INC. VAT	PRICE EXC. VAT	
<b>Powder Coated White RAL 9016</b>								
13.1	LSTH 2000/PC/RX/FAN	1000 x 500 x 100	1900	1900	6482	356.00	296.66	
13.2	LSTH 1000/PC/RX/FAN	600 x 300 x 100	950	950	3241	319.00	265.83	

RADIANT CEILING HEATER SYSTEMS (DEPTH 35mm)							EFS 1018	
LINE REF	CODE	DIMENSIONS (H X W X D) MM	ELEMENT (WATTS)	OUTPUT (WATTS)	OUTPUT (BTU'S)	PRICE INC. VAT	PRICE EXC. VAT	
<b>Powder Coated White RAL 9016</b>								
14.1	ECO 300/80/FF/RP/PC/RX	595 x 595 x 40	300	200	682	260.00	216.67	
14.3	ECO 750/80/FF/RP/PC/RX	1195 x 595 x 40	750	600	2047	419.00	349.17	
14.4	ECO 1000/80/FF/RP/PC/RX	1785 x 595 x 40	1000	800	2729	489.00	407.50	
14.5	ECO 1000/CE/RP/PC/RX	2000 x 500 x 40	1000	800	2729	489.00	407.50	
14.6	ECO 750/CE/RP/PC/RX	1500 x 500 x 40	750	600	2047	419.00	349.17	

**DISC HEAT CIRCLE**

<b>Powder Coated White RAL 9016</b>							
14.16	ECO 250/CIR/RP/PC/RX	614mm Diameter	500	400	1365	408.00	340.00

**Accessories**

14.20	Anti-Ligature Plate (x2 units)	950 x 100				36.00	30.00
14.20	Rear Fixing Plate for Ceiling Joists CEP-01 (x2 Units)					36.00	30.00

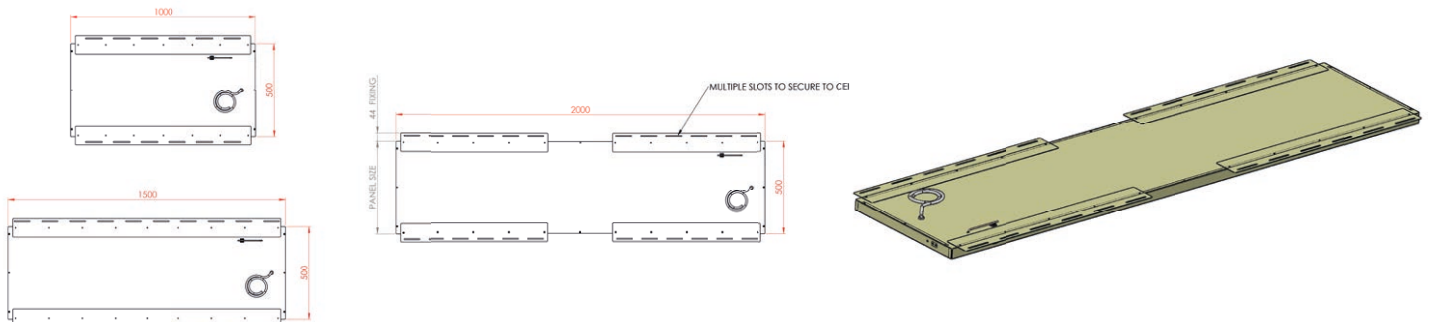

14.20 Anti-Ligature Plate



14.21 Ceiling Fixing Kit CE-01

4 x 0.6m each

12.00

10.00

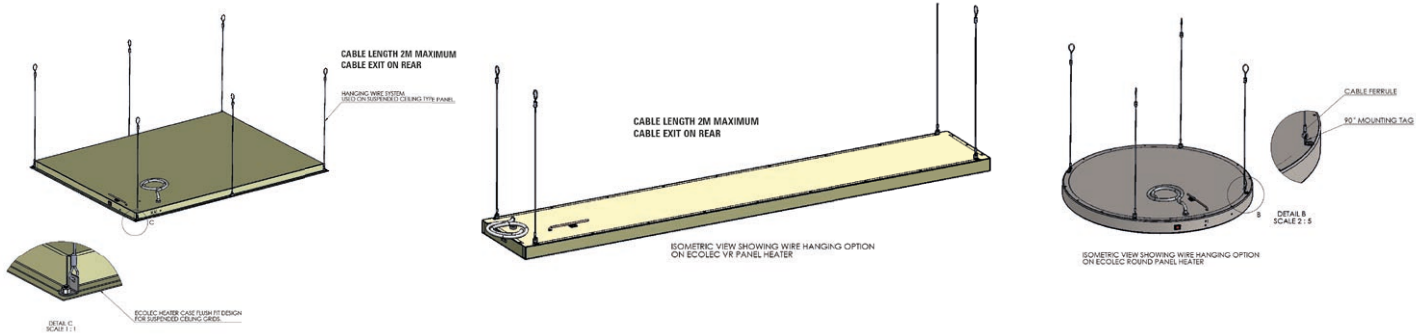

14.22 Adjustable Wall Brackets (Pair)

48.00

40.00

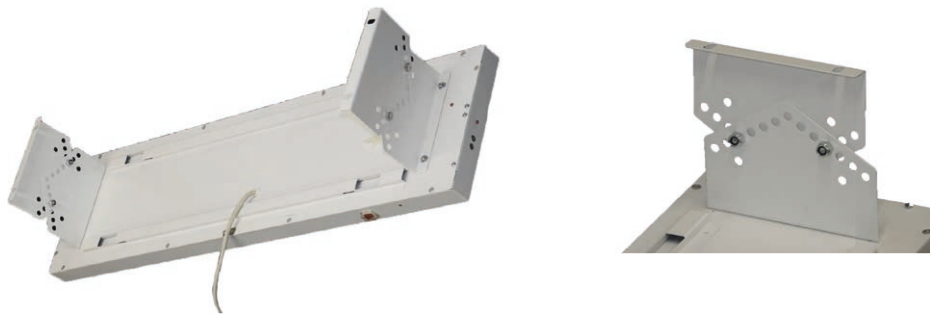

**CONTROLLERS**

**EFS 1037**

LINE REF	MODEL	SENSOR	POWER	PRICE INC. VAT	PRICE EXC. VAT
15.1	REMOTE THERMOSTAT/TIMER	WCT 100/TX	AIR	BATTERY	105.00 87.50
15.2	REMOTE THERMOSTAT/TIMER/ SURF TEMP ADJ 70 °C	WCT 500/TX/70	AIR	BATTERY	140.00 116.67
15.4	230V MAINS KIT FOR WCT 100TX/500TX	MK1	AIR	MAINS	72.00 60.00

**TRAPEZIUM ANTI-GLARE LED MIRROR RADIATOR (DEPTH 44mm)**

**AFS 1003**

LINE REF	CODE	DIMENSIONS (H X W X D) MM	LED (WATTS)	ELEMENT (WATTS)	OUTPUT (WATTS)	OUTPUT (BTU'S)	PRICE INC. VAT	PRICE EXC. VAT
<b>Powder Coated White RAL 9016</b>								
17.1	AUR 500D/PC/IP44/MR/LED	500 x 500 x 44	10	500	300	1023	610.00	508.33
17.2	AUR 1000D/PC/IP44/MR/LED	1000 x 500 x 44	20	1000	600	2047	750.00	625.00
17.3	AUR 1500D/PC/IP44/MR/LED	1500 x 500 x 44	30	1500	900	3070	830.00	691.67
17.4	AUR 750D/SB/PC/IP44/MR/LED	1500 x 250 x 44	30	750	450	1535	780.00	650.00

- CARRIAGE CHARGES NOT INCLUDED - ALL PRICES INCLUDE 20% VAT
- BESPOKE & SPECIAL NEEDS HEATERS AVAILABLE. PLEASE PHONE FOR A QUOTE
- WHEN DELIVERY IS MADE ON PALLETS, IT IS UPTO THE CUSTOMER TO UNLOAD AS THE DRIVER IS NOT CONTRACTED FOR THIS PURPOSE. ALL DELIVERIES ARE MADE TO THE GROUND FLOOR.
- ALL SPECIFICATIONS CAN CHANGE WITHOUT NOTICE.

- PLEASE CONSULT YOUR LOCAL NICEIC ELECTRICIAN
- CONNECT HEATERS TO A FUSED SPUR - BEST PRACTICE
- NON IP44 HEATERS CAN BE FITTED WITH A 13AMP PLUG